

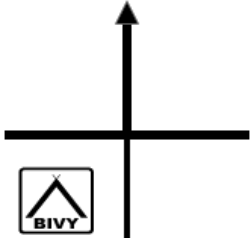







NL

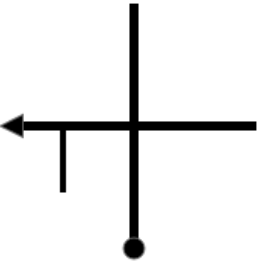
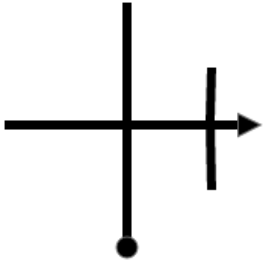
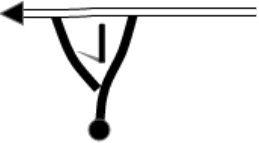

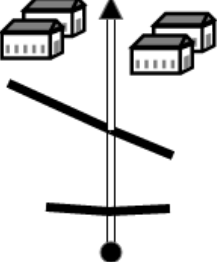

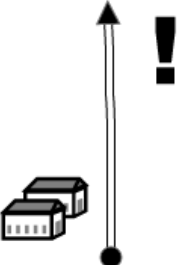
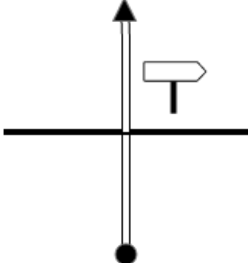

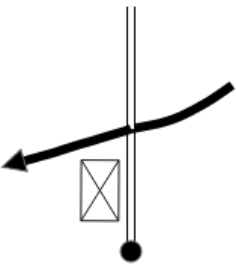

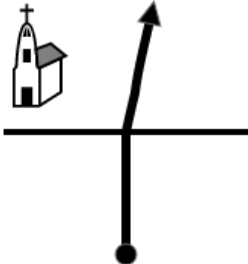

- Leopoldsburg
- Hechtel
- Eksel
- Lommel
- Leopoldsburg

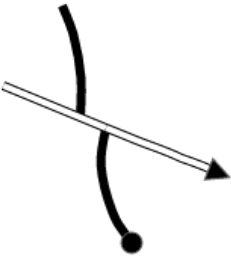
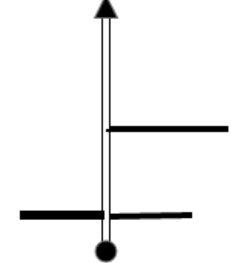
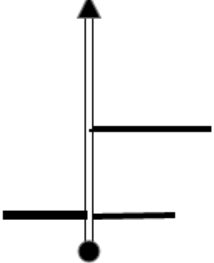
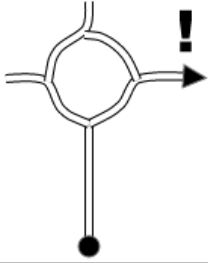

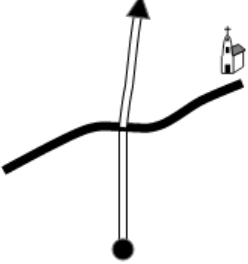

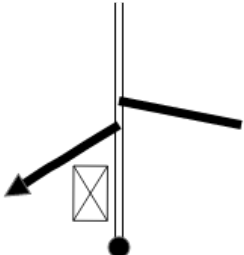

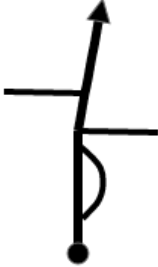
55 km

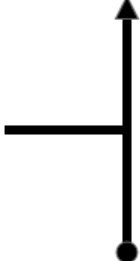
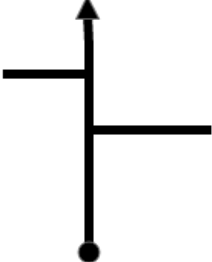

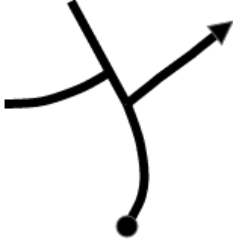

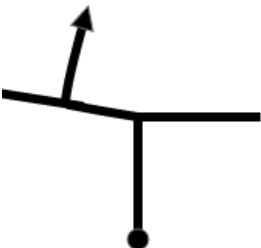
0.00		 Camp Splendid START
1 0.00		CAP 176°
0.22		CAP 082°
2 0.22		
0.47		CAP 174°
3 0.24		CAP 174°
0.74		Monument Tacambaro 
4 0.27		CAP 083°
0.86		Kazerne Leopoldsburg
5 0.12		CAP 083°



<p>2.39</p>		<p>! Sanicole</p>
<p>6 1.52</p>		<p>CAP 081°</p>
<p>4.60</p>		<p>Doorgang E</p> 
<p>7 2.21</p>		<p>CAP 081°</p>
<p>6.53</p>		<p>CAP 090°</p>
<p>8 1.93</p>		
<p>7.44</p>		<p>De klets kop</p> 
<p>9 0.92</p>		<p>CAP 004°</p>
<p>7.52</p>		<p>CAP 016°</p>
<p>10 0.07</p>		

7.64		 CAP 026°
11 0.12		CAP 171°
7.76		CAP 171°
7.94		CAP 171°
8.05		 Klein Caen CAP 133°
8.28		CAP 292°
15 0.23		



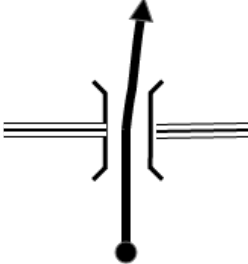

8.66		 Musty Kebap
16      0.38		CAP 149°
8.95		
17      0.29		CAP 160°
9.03		
18      0.09		CAP 257°
9.23		
19      0.19		CAP 267°
9.37		
20      0.14		CAP 267°

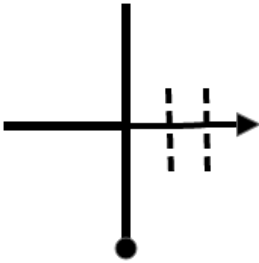
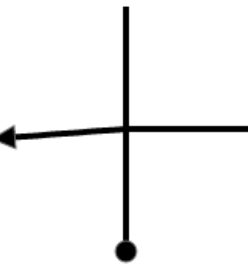
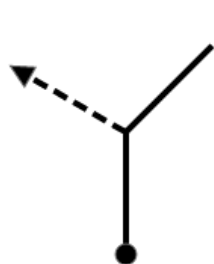

<p>9.79</p>		<p>CAP 255°</p>
<p>21      0.41</p>		
<p>9.93</p>		<p>CAP 176°</p>
<p>22      0.14</p>		
<p>10.19</p>		<p>CAP 115°</p>
<p>23      0.26</p>		
<p>10.42</p>		 <p>CAP 276°</p>
<p>24      0.23</p>		
<p>10.58</p>		<p>CAP 085°</p>
<p>25      0.16</p>		



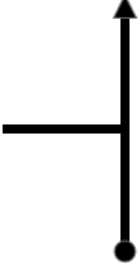
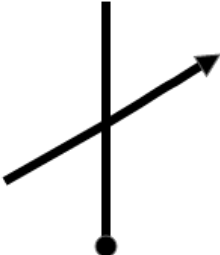

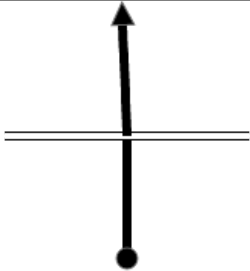
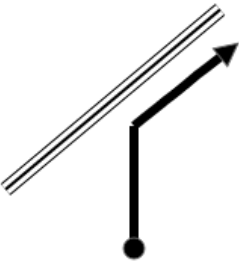
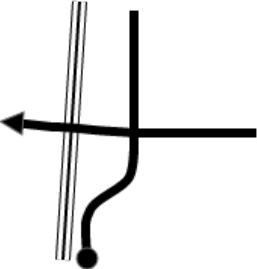
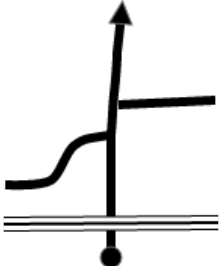

<p>11.11</p>		<p>CAP 085°</p>
<p>26 0.53</p>		<p>! Don Bosco</p> <p>CAP 058°</p>
<p>11.61</p>		<p>CAP 124°</p>
<p>27 0.50</p>		<p>CAP 171°</p>
<p>12.10</p>		<p>CAP 052°</p>
<p>28 0.49</p>		<p>CAP 052°</p>
<p>29 0.20</p>		<p>CAP 052°</p>
<p>30 0.36</p>		<p>CAP 052°</p>



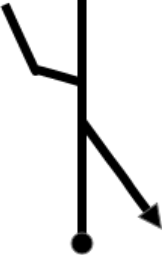

<p>12.92</p>		<p>CAP 086°</p>
<p>31      0.27</p>		
<p>13.06</p>		<p>CAP 070°</p>
<p>32      0.14</p>		
<p>13.55</p>		<p>CAP 159°</p>
<p>33      0.49</p>		
<p>13.92</p>		<p>CAP 065°</p>
<p>34      0.37</p>		
<p>14.05</p>		<p>CAP 005°</p>
<p>35      0.13</p>		







<p>14.50</p>		<p>CAP 028°</p>
<p>36      0.45</p>		
<p>14.85</p>		<p>CAP 034°</p>
<p>37      0.35</p>		
<p>15.04</p>		<p>CAP 034°</p>
<p>38      0.19</p>		
<p>15.64</p>		<p>CAP 048°</p>
<p>39      0.61</p>		
<p>16.12</p>		<p>CAP 357°</p>
<p>40      0.48</p>		

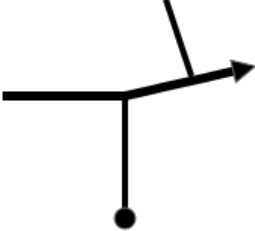

<p>16.26</p>		<p>CAP 355°</p>
<p>41      0.13</p>		<p>CAP 022°</p>
<p>17.58</p>		<p>CAP 308°</p>
<p>43      0.59</p>		<p>CAP 312°</p>
<p>17.70</p>		<p>CAP 331°</p>
<p>45      0.28</p>		<p>CAP 331°</p>

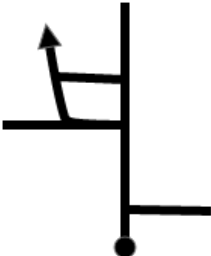
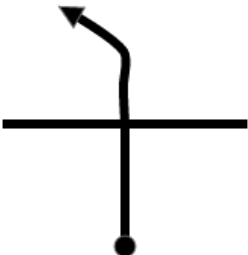
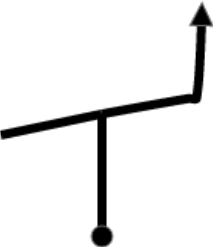

<p>18.26</p>		<p>CAP 350°</p>
<p>46 0.28</p>		
<p>18.63</p>		<p>CAP 007°</p>
<p>47 0.37</p>		
<p>18.83</p>		 <p>CAP 151°</p>
<p>48 0.21</p>		
<p>18.96</p>		<p>! Stermolen</p> <p> Brasserie De meule</p> <p>CAP 114°</p>
<p>49 0.12</p>		
<p>19.75</p>		<p>CAP 298°</p>
<p>50 0.79</p>		

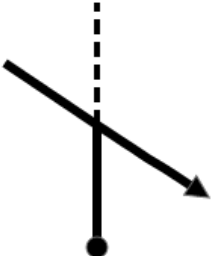
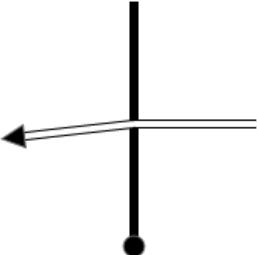
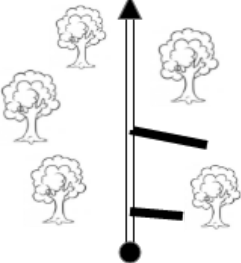
20.42		CAP 220°
51      0.67		
20.66		CAP 196°
52      0.24		
20.91		CAP 230°
53      0.25		
21.46		CAP 295°
54      0.55		
22.01		CAP 134°
55      0.55		

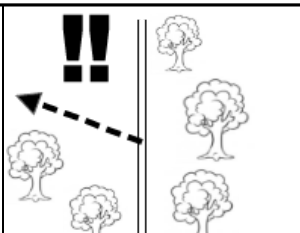
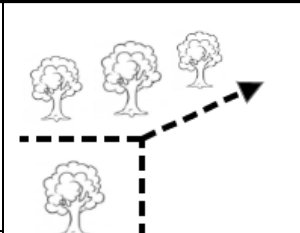
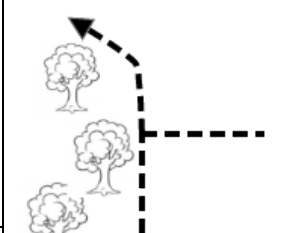

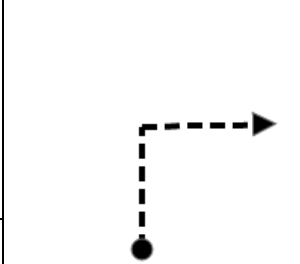
<p>22.44</p>		<p>CAP 288°</p>
<p>56 0.43</p>		
<p>23.08</p>		 <p>CAP 277°</p>
<p>57 0.64</p>		
<p>23.46</p>		<p>CAP 260°</p>
<p>58 0.38</p>		
<p>23.78</p>		<p>CAP 350°</p>
<p>59 0.31</p>		
<p>25.17</p>		<p>CAP 039°</p>
<p>60 1.39</p>		

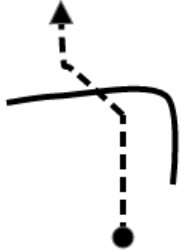
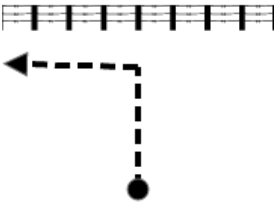
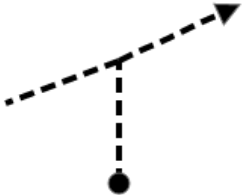
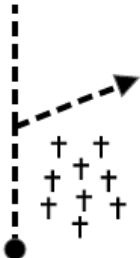

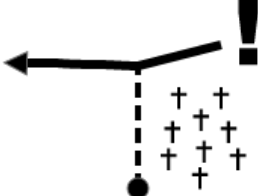
<p>25.77</p>		<p>CAP 063°</p>
<p>61      0.60</p>		
<p>26.25</p>		<p>CAP 330°</p>
<p>62      0.49</p>		
<p>26.81</p>		<p>CAP 093°</p>
<p>63      0.55</p>		
<p>28.29</p>		<p>CAP 358°</p>
<p>64      1.48</p>		
<p>29.94</p>		<p>CAP 358°</p>
<p>65      1.65</p>		



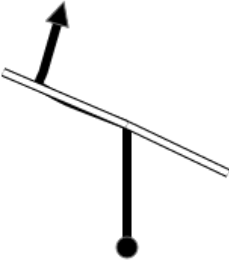
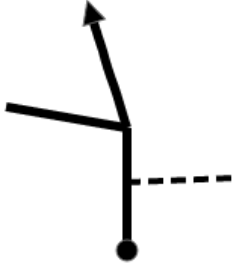
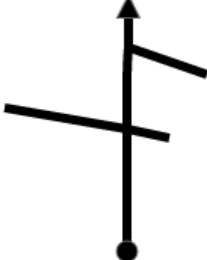

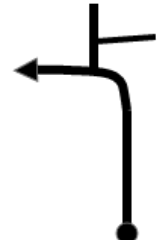
<p>30.66</p>		<p>!! Open vlakte</p>
<p>66 0.72</p>		<p>CAP 289°</p>
<p>31.55</p>		
<p>67 0.89</p>		<p>CAP 010°</p>
<p>31.77</p>		
<p>68 0.22</p>		<p>CAP 010°</p>
<p>32.22</p>		<p>!!! Opgelet voor fietsers</p>
<p>69 0.45</p>		<p>CAP 219°</p>
<p>32.95</p>		
<p>70 0.73</p>		<p>CAP 308°</p>

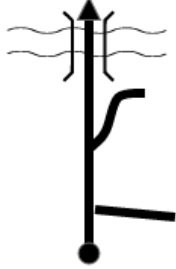
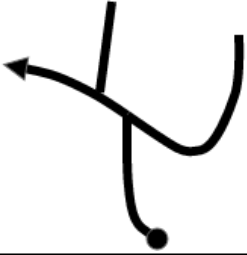
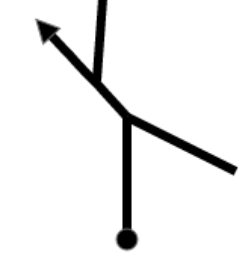
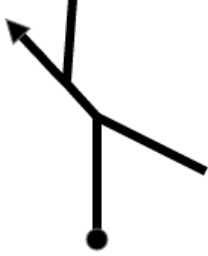
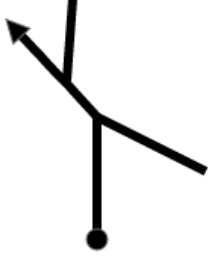

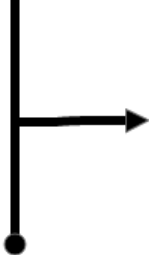
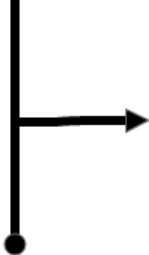
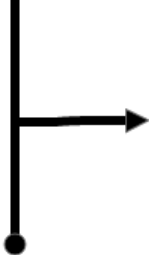
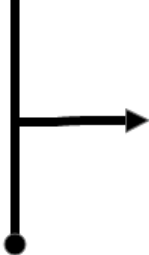
<p>33.81</p>		<p>CAP 270°</p>
<p>71 0.86</p>		
<p>34.05</p>		<p>CAP 219°</p>
<p>72 0.24</p>		
<p>34.69</p>		<p>CAP 284°</p>
<p>73 0.64</p>		
<p>36.15</p>		 <p>CAP 337°</p>
<p>74 1.46</p>		
<p>36.57</p>		<p>! Bezoekerscentrum  Duitse begraafplaats</p> <p>CAP 248°</p>
<p>75 0.42</p>		

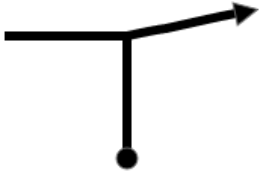

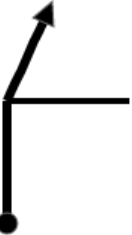
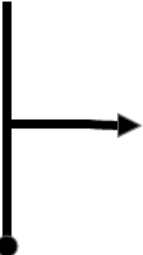



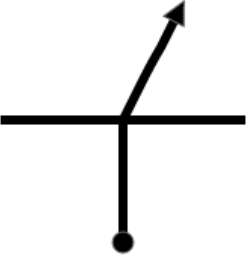
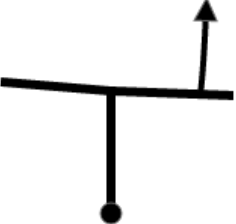

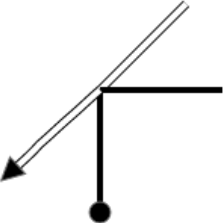

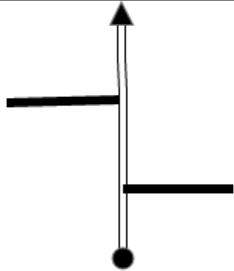

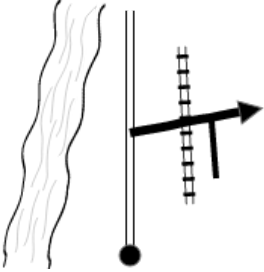

36.79		CAP 190°
76      0.22		
37.60		CAP 241°
77      0.81		
38.41		CAP 260°
78      0.81		
39.05		CAP 344°
79      0.64		
39.24		CAP 289°
80      0.20		

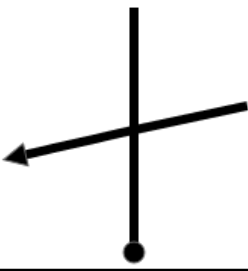
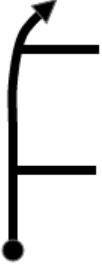
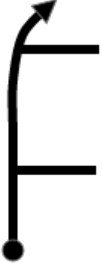

<p>39.54</p>		<p>CAP 225°</p>
<p>81      0.49</p>		<p>CAP 224°</p>
<p>39.80</p>		<p>CAP 181°</p>
<p>82      0.27</p>		<p>CAP 181°</p>
<p>39.98</p>		<p>CAP 127°</p>
<p>83      0.18</p>		<p>! Ambachtelijk ijs</p>
<p>41.09</p>		<p>CAP 127°</p>
<p>84      1.11</p>		<p>CAP 269°</p>
<p>41.56</p>		<p>CAP 269°</p>
<p>85      0.46</p>		<p>CAP 269°</p>

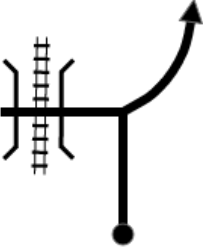
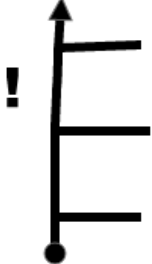

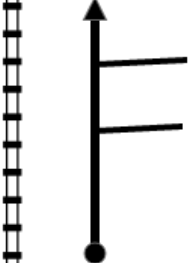

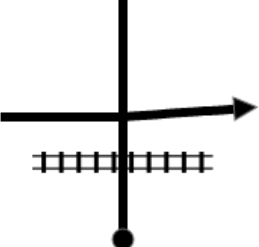
<p>41.76</p>		<p>CAP 347°</p>
<p>86 0.20</p>		 <p>CAP 277°</p>
<p>42.64</p>		<p>CAP 302°</p>
<p>88 0.81</p>		<p>CAP 238°</p>
<p>42.94</p>		<p>CAP 157°</p>
<p>90 0.18</p>		

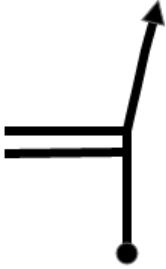
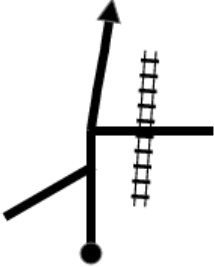
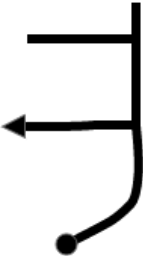
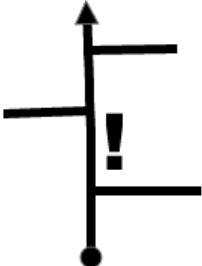
43.46		
91	0.34	CAP 184°
44.31		
92	0.85	CAP 270°
44.57		
93	0.25	CAP 185°
46.22		
94	1.66	CAP 273°
46.94		
95	0.72	CAP 131°

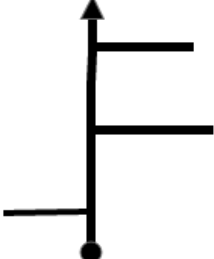

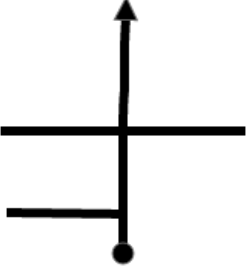
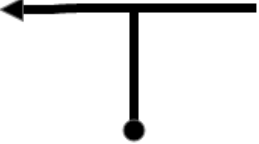
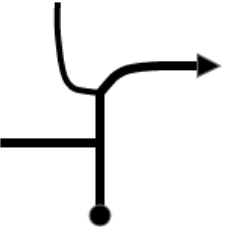
48.24		
96 1.29		CAP 130°
48.62		<p>! Beregoed Koepel Staghound</p>
97 0.38		CAP 133°
48.83		
98 0.21		CAP 212°
49.32		CAP 105°
99 0.49		CAP 106°
49.93		CAP 106°
100 0.60		CAP 106°

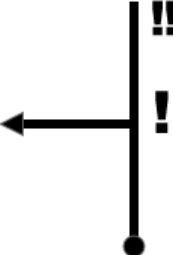

<p>50.22</p>		<p>CAP 184°</p>
<p>101      0.30</p>		
<p>50.71</p>		 <p>CAP 170°</p>
<p>102      0.49</p>		
<p>51.02</p>		<p>CAP 170°</p>
<p>103      0.31</p>		
<p>51.22</p>		<p>CAP 087°</p>
<p>104      0.20</p>		
<p>51.33</p>		<p>CAP 173°</p>
<p>105      0.10</p>		

<p>51.44</p>		<p>CAP 186°</p>
<p>106      0.11</p>		<p>CAP 222°</p>
<p>52.20</p>		<p>CAP 083°</p>
<p>108      0.45</p>		<p>! MKOK    CAP 081°</p>
<p>52.53</p>		<p>CAP 083°</p>
<p>110      0.20</p>		

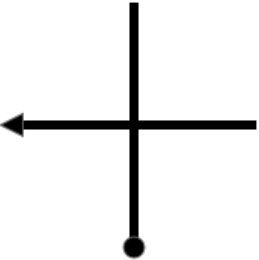
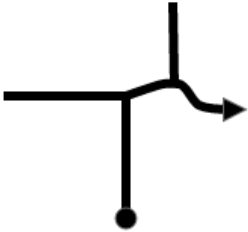
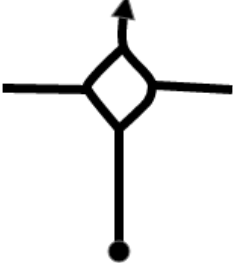
<p>52.79</p>		<p>CAP 084°</p>
<p>111      0.27</p>		
<p>52.93</p>		<p>CAP 353°</p>
<p>112      0.14</p>		
<p>53.20</p>		 <p>CAP 056°</p>
<p>113      0.27</p>		
<p>53.31</p>		<p>! Mil. begraafplaats (BE)  !! 500m: Mil. begraafplaats (UK)</p> <p>CAP 353°</p>
<p>114      0.11</p>		
<p>53.52</p>		<p>CAP 353°</p>
<p>115      0.20</p>		

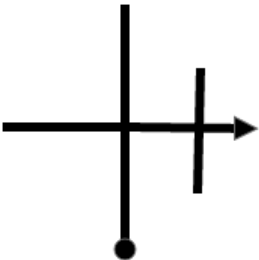

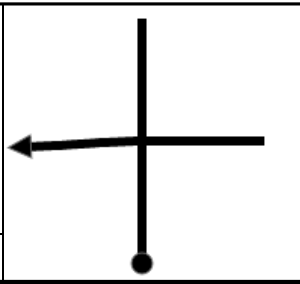
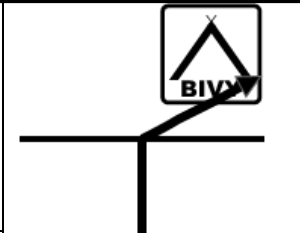
<p>53.72</p>		<p>CAP 263°</p>
<p>116      0.20</p>		
<p>53.81</p>		<p>CAP 335°</p>
<p>117      0.09</p>		
<p>54.00</p>		<p>CAP 355°</p>
<p>118      0.19</p>		
<p>54.19</p>		<p>! Standbeeld !! Gemeentehuis</p> <p>CAP 357°</p>
<p>119      0.18</p>		
<p>54.30</p>		<p>CAP 086°</p>
<p>120      0.11</p>		

<p>54.56</p>		<p>CAP 351°</p>
<p>121      0.26</p>		<p> Camp Splendid <b>FINISH</b></p>
<p>122      0.22</p>		<p>CAP 058°</p>